

WOOD VENEER SERIES

PART II

**GLOBAL WOODEN
DOOR MANUFACTURER**



SOLID COMPOSITE WOODEN DOOR SERIES

01

Solid Composite Wooden Door Series(OPS)

实木复合门

- Scientific Structure
- More Veneer and Color Choosing
- Nature and Design Plentiful
- Environmental Protection



SD-8688



SD-8689



SD-8690



SD-8691



SD-8692



SD-8693



SD-8694



SD-8695



SD-8696



SD-8697



SD-8698



SD-8699



SD-8700



SD-8701



SD-8702



SD-8703



SD-8704



SD-8705



SD-8706



SD-8707



SD-8708



SD-8709



SD-8710



SD-8711



SD-8712



SD-8713



SD-8714



SD-8715



SD-8716



SD-8717



SD-8718



SD-8719



SD-8720



SD-8721



SD-8722



SD-8723



SD-8724



SD-8725



SD-8726



SD-8727





SD-8628

SD-8630

SD-8631

SD-8632

SD-8633

Wood Veneer Frame Series

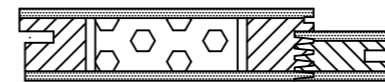

XFS-001

实木复合烤漆门新A型插口门套

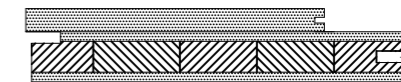

XFS-002

实木复合烤漆门A型插口门套

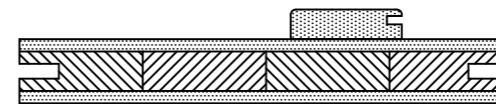

XFS-003

实木复合烤漆门B型插口门套

Wood Veneer Architrave Series

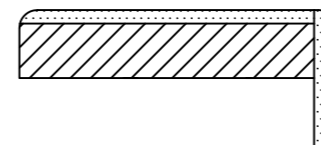

XLS-001

实木复合烤漆门直角插口线条

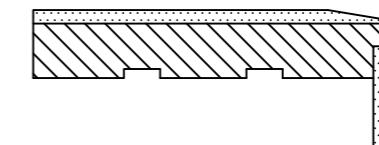

XLS-002

实木复合烤漆门斜角插口线条

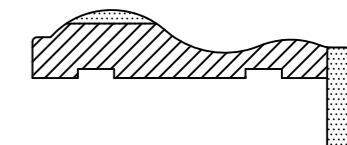

XLS-003

实木复合烤漆门欧式插口线条

OPS Recommend Color

荣耀OPS系列色板



SKS-003
Sapele-01
沙比利一号

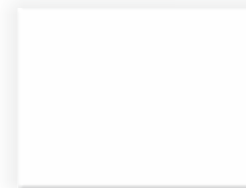

SKS-009
Pure White
纯白

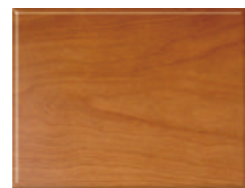

SKS-015
Cherry Wood
樱桃一号



SKS-016
Cherry Wood
樱桃二号



SKS-017
Golden Teak Wood
金丝柚色



SKS-022
Red Oak
(White Open Painting)
红橡白开放



SKS-025
Antique White
仿古白



SKS-026
Antique Walnut
仿古胡桃



SKK-005
Red Oak-02
红橡二号

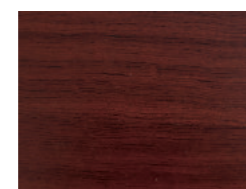

SKK-009
Rosewood-02
红花梨二号



ACCESSORIES

PART III

GLOBAL WOODEN
DOOR MANUFACTURER

Glass

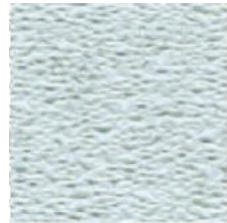

GA-201
钻石



GA-202
磨砂



GA-204
满天星



GA-205
流星岁月

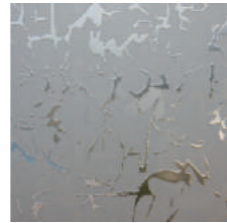

GA-206
冰凌

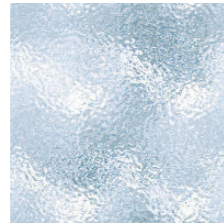

GA-207
银霞



GA-301
白玻



GA-303
玉砂条纹工艺玻璃

Hardware



HAS-003



HAS-004



HAS-007



HAS-008



HAS-013



HAS-014



HAS-015



HAS-016



HAS-017



HAS-018



HAS-301



HAS-304



HAS-305



HAS-306



HAS-307



HAS-308



HAS-315



HAJ-501
无字不锈钢子母合页



HAJ-504
无字不锈钢平开合页



HAQ-001
插销



OTHERS

PART IV

**GLOBAL WOODEN
DOOR MANUFACTURER**

Instruction for Installation

1 .Part of door installation

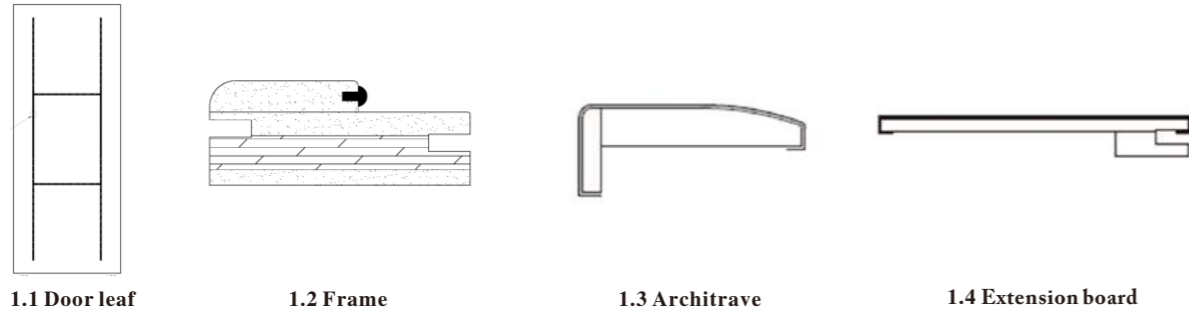

2 .Hardware

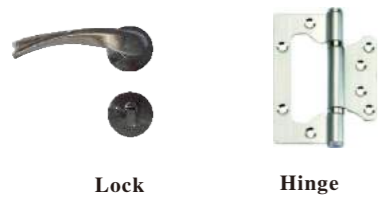

3 .Installation of frame and architrave

3.1 Installation complete diagram, as Item 1:

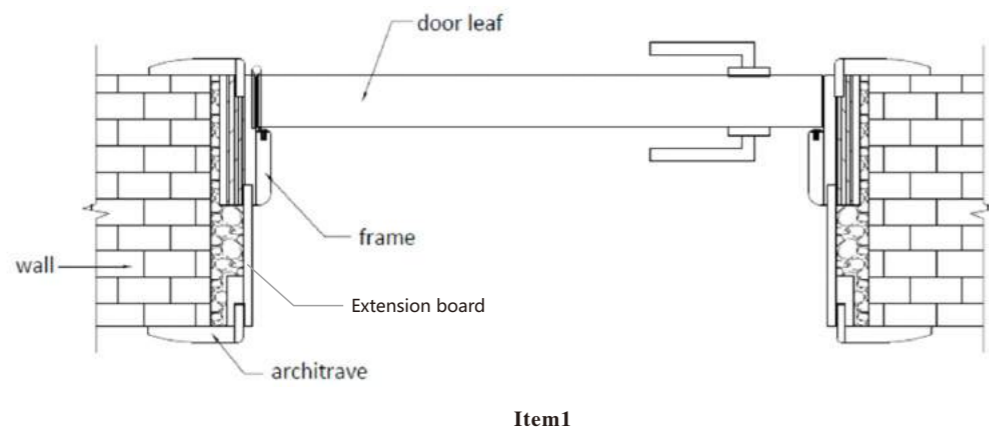

Step 1:
The frame using the 45 degree angle and groove joint ways, put the adjustable board into frame. as Item 2 and Item 3:

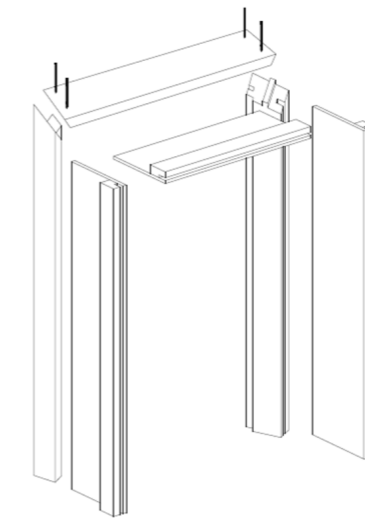
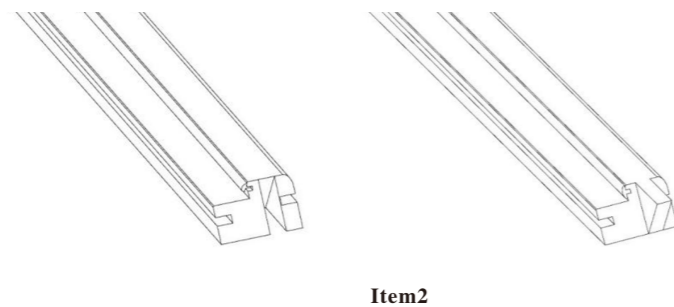

Item3

Step 2:
(1) Push the assembled frame into wall hole, keep it upright of both sides. Make the frame and wall fixed with nails. As Item 4.

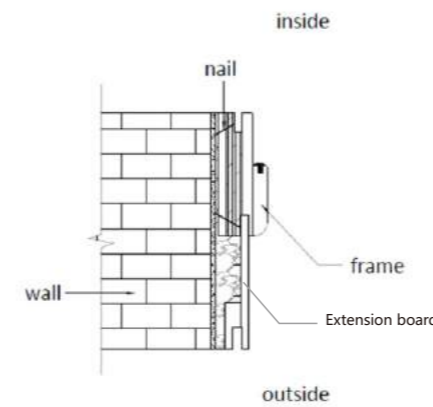

(2) Use a wood strip to support the frame and ensure it upright. Inpouring the foaming glue beside the frame and wall. As Item 5.

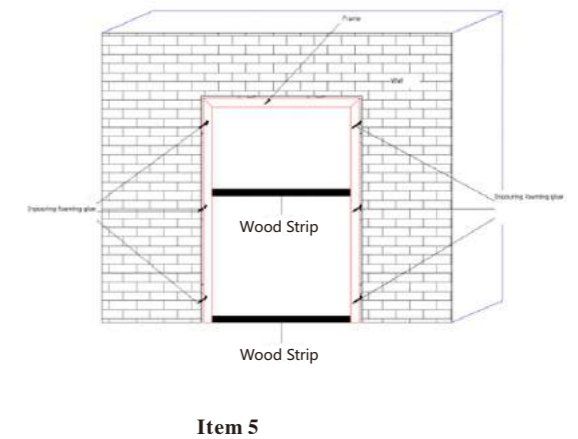

Step 3:
(1) Architrave need to be cut by small cutting machine according to the actual length. One end of the longer architrave should be cut as 45°. As Item 6 ;

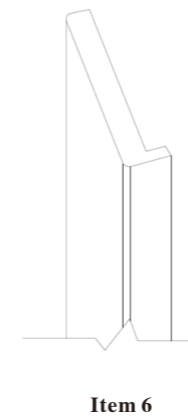

(2) Architrave also can adjust the wall thickness. Applying glass glue on the back of architraves, then fix with frame. As item 7:

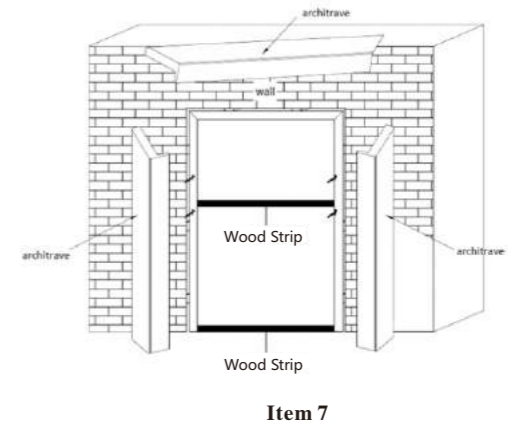

Quality Control



Quality Team:73 people

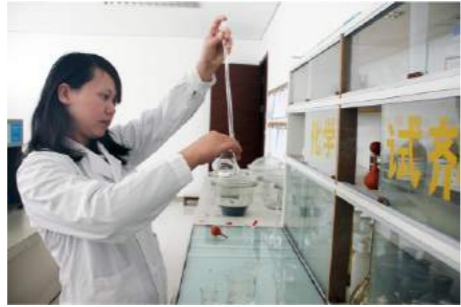

Raw Materials Inspection

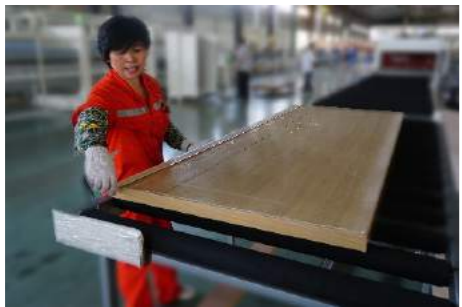

Finished Goods Inspection



Process Inspection

First Class Production Line



Sales Network

